

LI-0120-P3
56 x 15 x 10 cm.

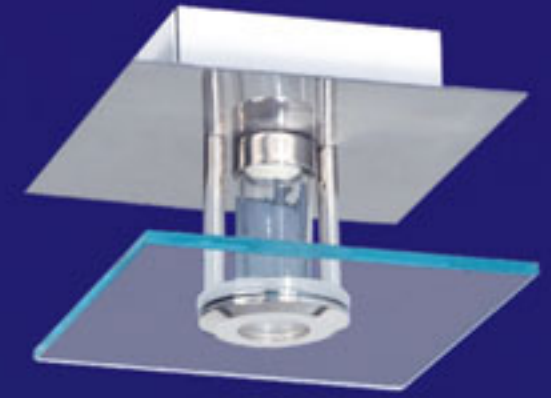

LI-0120-P1
15 x 15 x 10 cm.



LI-0120-P2
32 x 12 x 10 cm.

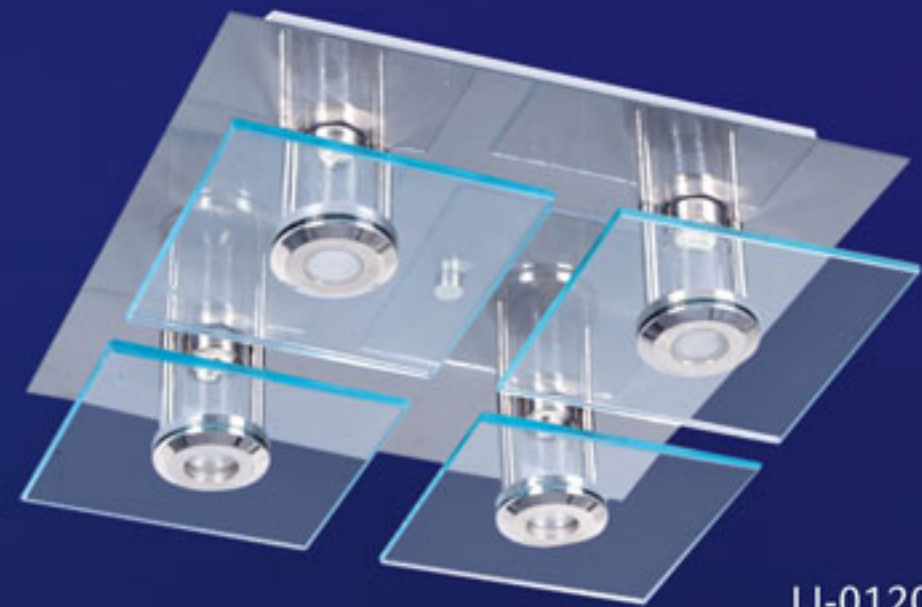

LI-0120-P4
32 x 32 x 10 cm.

L í n e a



Marbella
Transparente

G9
Acabado Platil



LI-0120-R4
76 x 15 x 100 cm.



LI-0120-R3
56 x 15 x 100 cm.



LI-0120-R5
96 x 15 x 100 cm.



LI-0100-R3
56 x 15 x 100 cm.

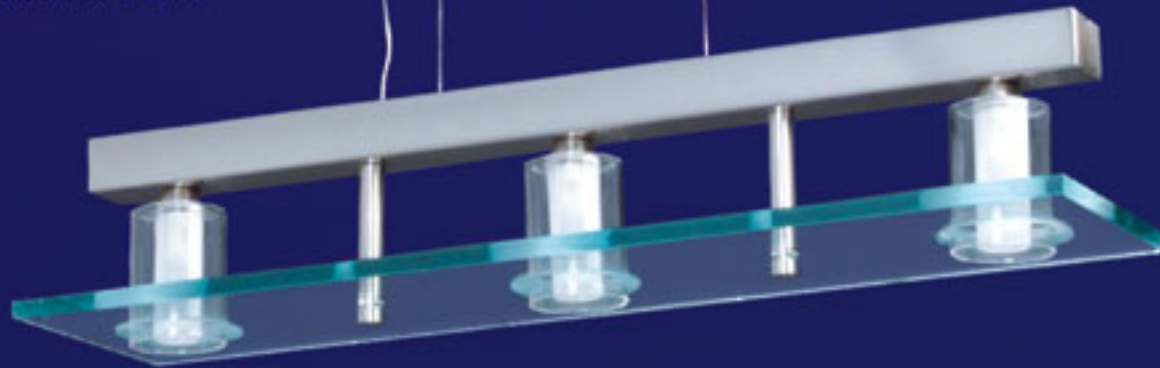

LI-0100-R5
96 x 15 x 100 cm.



LI-0100-R4
76 x 15 x 100 cm.



Línea



Niza
Transp. Satinado

G9
Acabado Platil

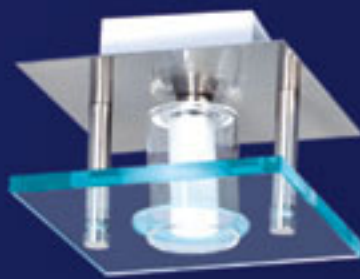

LI-0100-P1
15 x 15 x 10 cm.



LI-0100-P2
32 x 12 x 10 cm.



LI-0100-P4
32 x 32 x 10 cm.



LI-0100-P3
56 x 15 x 10 cm.

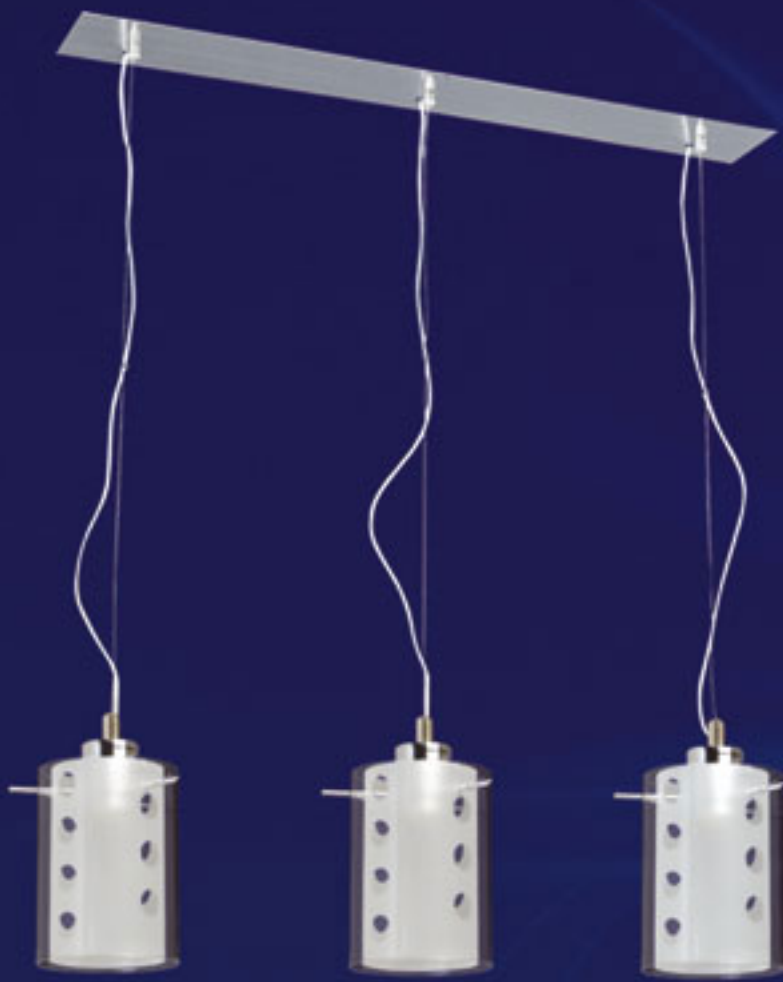

LI-8007-C3
80 x 12 x 100 cm.



LI-8007-R5
96 x 12 x 100 cm.



LI-8007-LP
15 x 170 cm.



LI-8007-C2
60 x 12 x 100 cm.



LI-8007-R3
56 x 12 x 100 cm.



LI-8007-A2
38 x 24 x 16 cm.



LI-8007-R4
76 x 12 x 100 cm.



LI-8007-VE
15 x 32 cm.



LI-8007-A1
12 x 24 x 16 cm.



LI-8007-C1
20 x 12 x 100 cm.



L i n e a



8006



E27

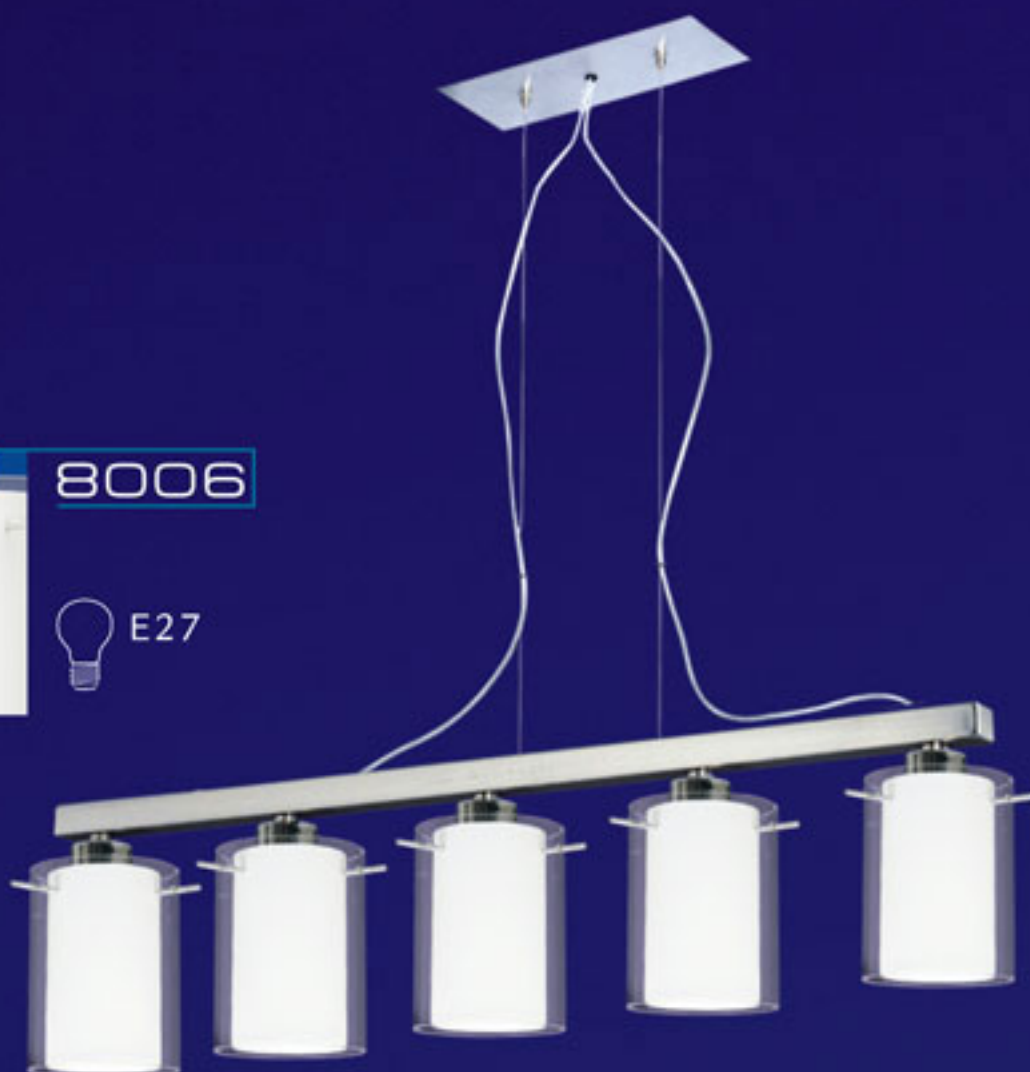

LI-8006-R5
96 x 12 x 100 cm.



LI-8006-C3
80 x 12 x 100 cm.



LI-8006-LP
15 x 170 cm.



LI-8006-C2
60 x 12 x 100 cm.



LI-8006-R3
56 x 12 x 100 cm.



LI-8006-A2
38 x 24 x 16 cm.



LI-8006-R4
76 x 12 x 100 cm.



LI-8006-VE
15 x 32 cm.



LI-8006-A1
12 x 24 x 16 cm.



LI-8006-C1
20 x 12 x 100 cm.

Línea París



PL 6209 300 mm. (1L-E27)
PL 6210 300 mm. (1L-G9)



PL 6207 200 mm. (1L-E27)
PL 6208 200 mm. (1L-G9)



PL 6215 280 x 120 mm. (2L-G9)



PL 6216 400 x 200 mm. (2L-G9)
PL 6217 400 x 200 mm. (2x26w)



PL 6219 500 x 250 mm. (3L-G9)
PL 6220 500 x 250 mm. (2x36w)



PL 6218 320 x 320 mm. (4L-G9)



VIGNOLO ILUMINACION



LI-0090-R3
ancho 60 cm
3 x G9



LI-0090-R4
ancho 80 cm
4 x G9



LI-0090-R5
ancho 100 cm
5 x G9



LI-0080-C1



LI-0080-C2
ancho 60 cm



LI-0080-C3
ancho 80 cm



LI-0080-R4
ancho 75 cm



LI-0080-R3
ancho 55 cm



LI-0080-R5
ancho 95 cm



JU-B2ME-PL



JU-B3ME-PL



JU-B4ME-PL

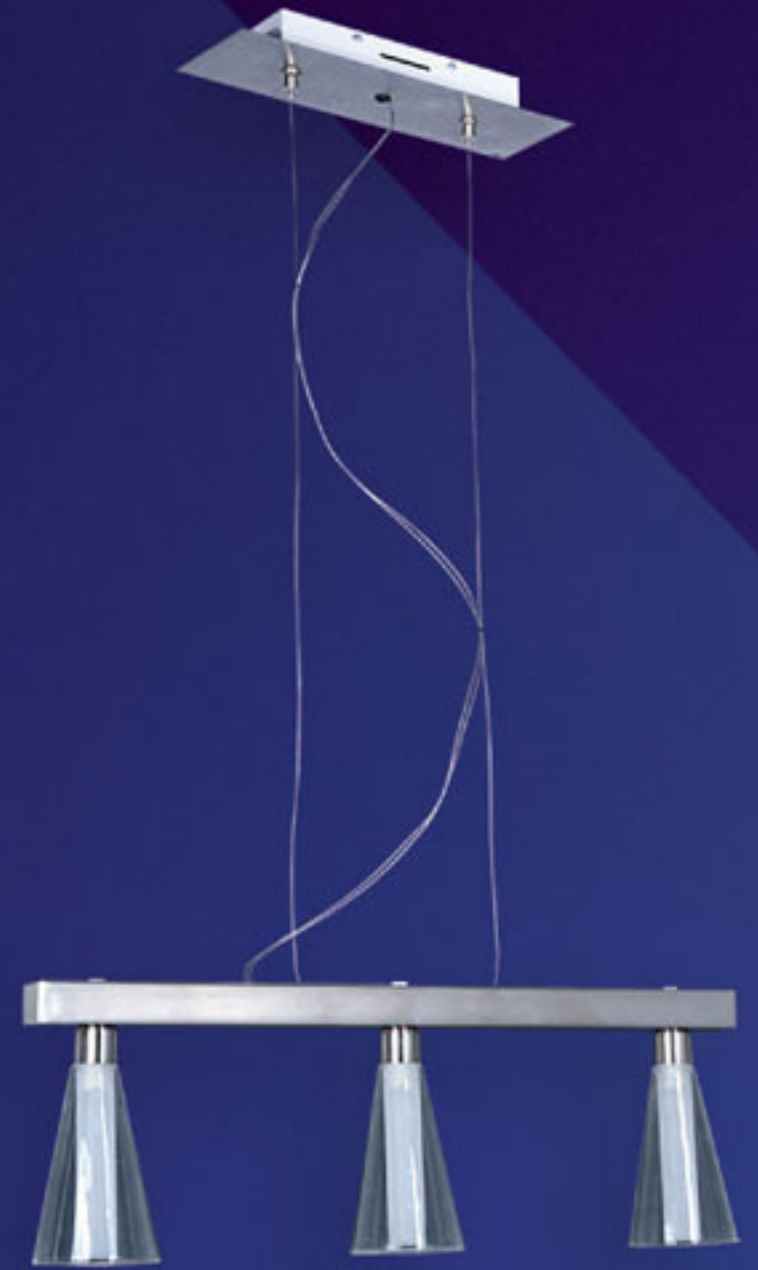

JU-R3ME-PL
ancho 55 cm

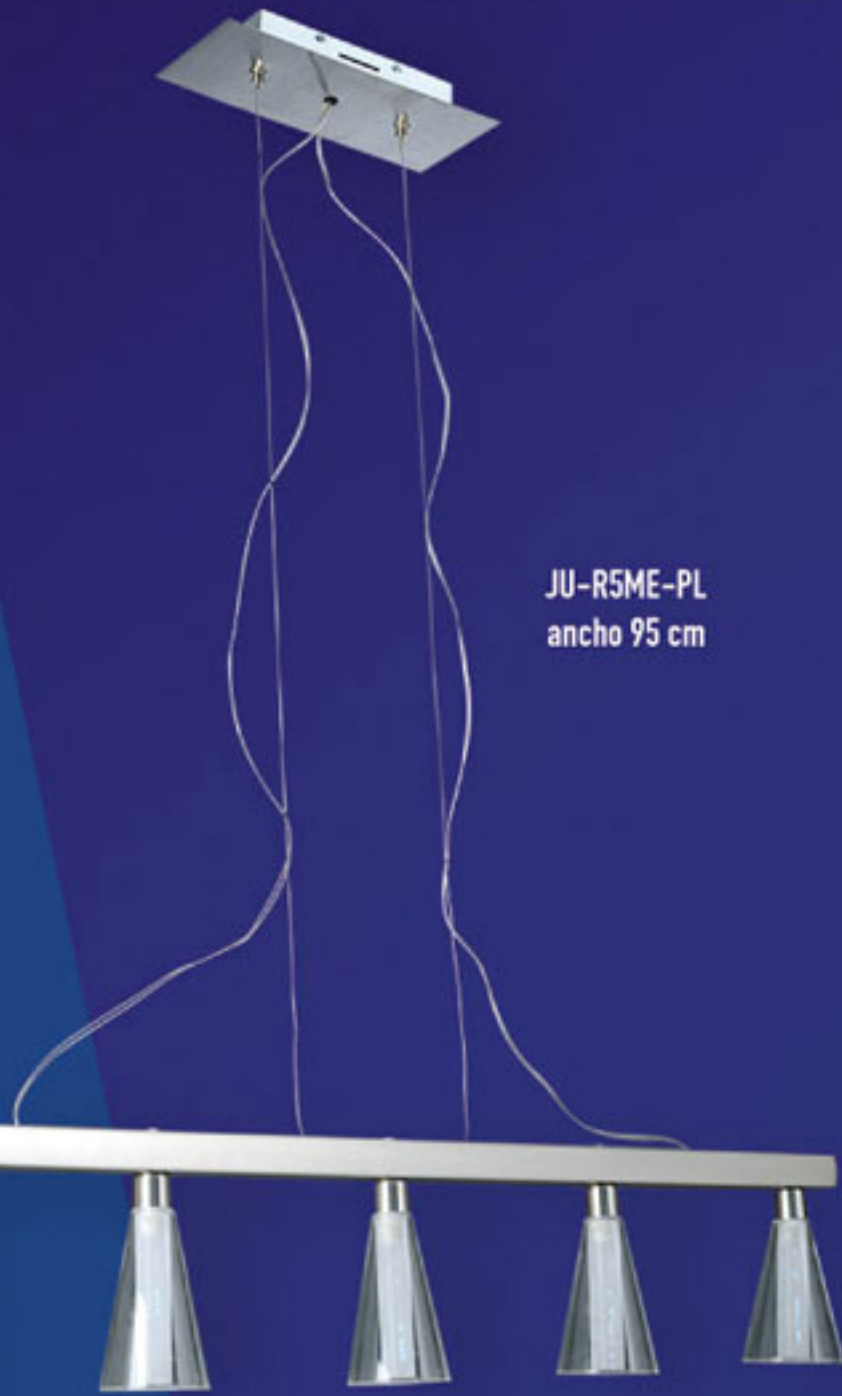

JU-R5ME-PL
ancho 95 cm

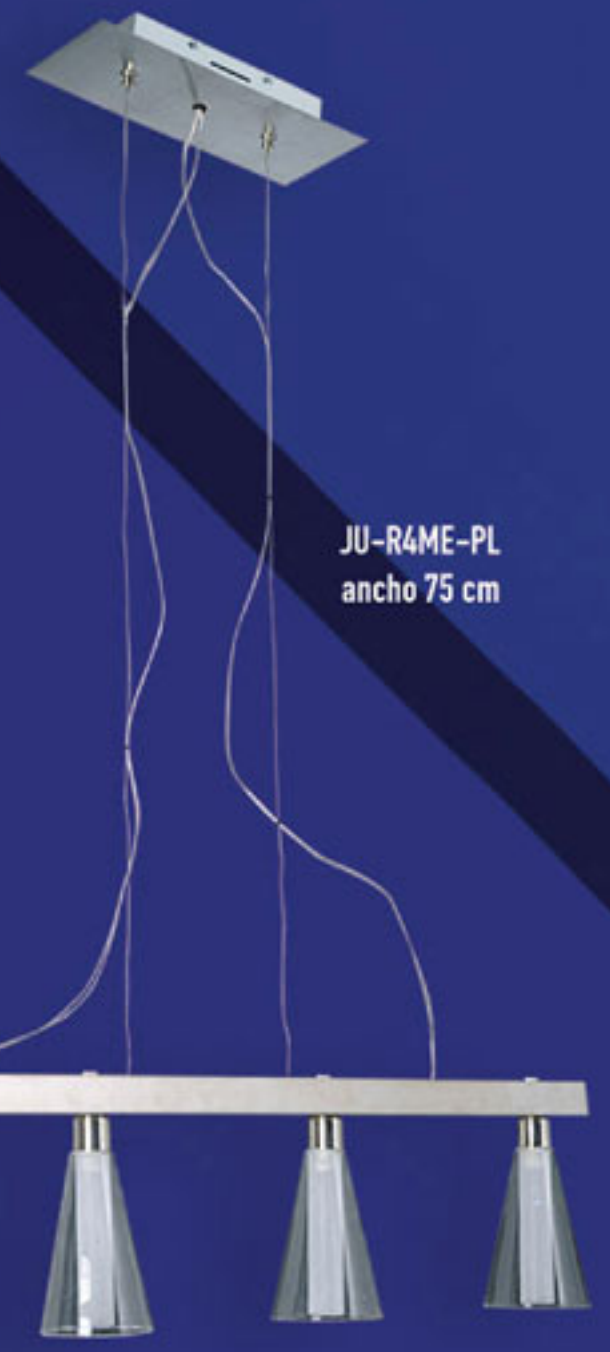

JU-R4ME-PL
ancho 75 cm



JU-02ME-PL



JU-03ME-PL



JU-C4ME-PL

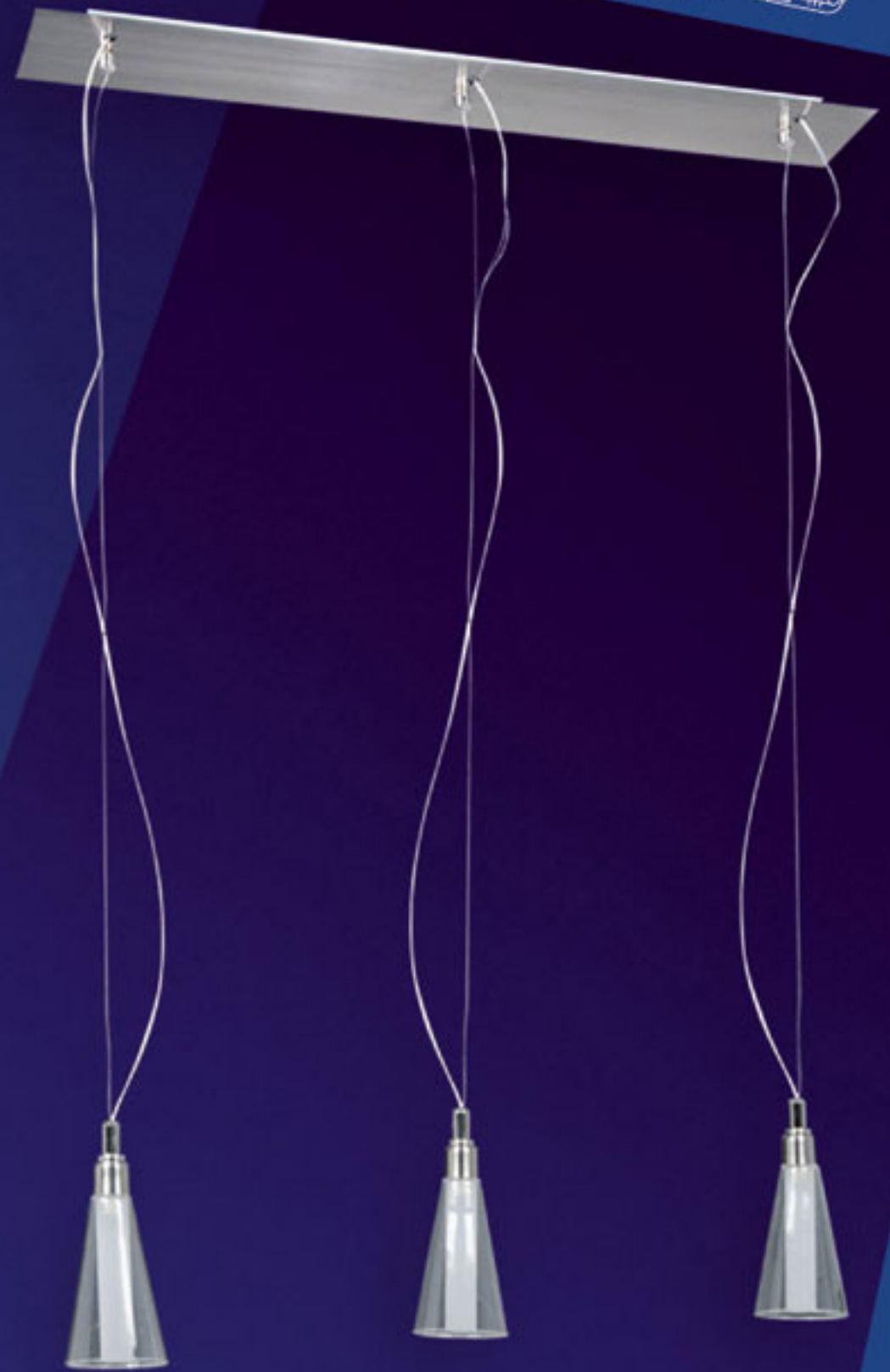

JU-C3ME-PL
ancho 80 cm



JU-C1ME-PL



JU-C2ME-PL
ancho 60 cm



LP-0401



LP-0402



LP-0400



LP-0403-CE (cedro)



LP-0403-WE (wengue)



LP-0408



LP-0409



LP-0407



GRIS - GRIS



GRIS - NEGRO



GRIS - AZUL



KT-030 A



BAJO CONSUMO



GRIS - GRIS



GRIS - NEGRO

KT-038 B



BAJO CONSUMO



KT205



BIPIN
50W



NEGRO



GRIS

KT310



BIPIN
50W



NEGRO



GRIS



FA-4201



FA-6201a

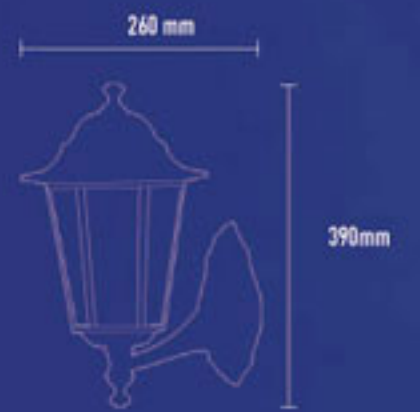

FA-7002

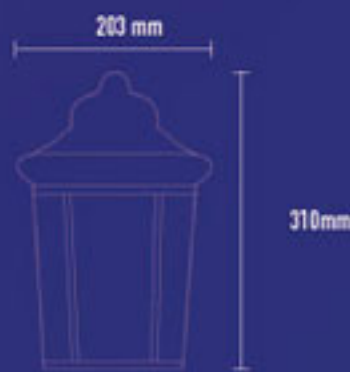

FA-6107

